

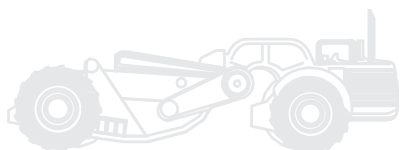

Timing Belts 101

Introduction to Timing Belts and Systems



GATES

Professional Development

SERIES

Introduction to Timing Belts and Systems

Table of Contents

Timing System Overview.....	Page 2
Engines	Page 4
System Components.....	Page 6
Belts.....	Page 8
Failure Modes.....	Page 13
Timing Belt Troubleshooting	Page 17
PowerGrip™ Timing Tensioner Kits.....	Page 19

Timing System Overview

Why a Synchronous Belt in Automotive Engines?

Synchronous belt drive systems, used to synchronize cam and crank shafts, replaced the classical chain drives when overhead camshafts were introduced into engine technology in the 1970s.

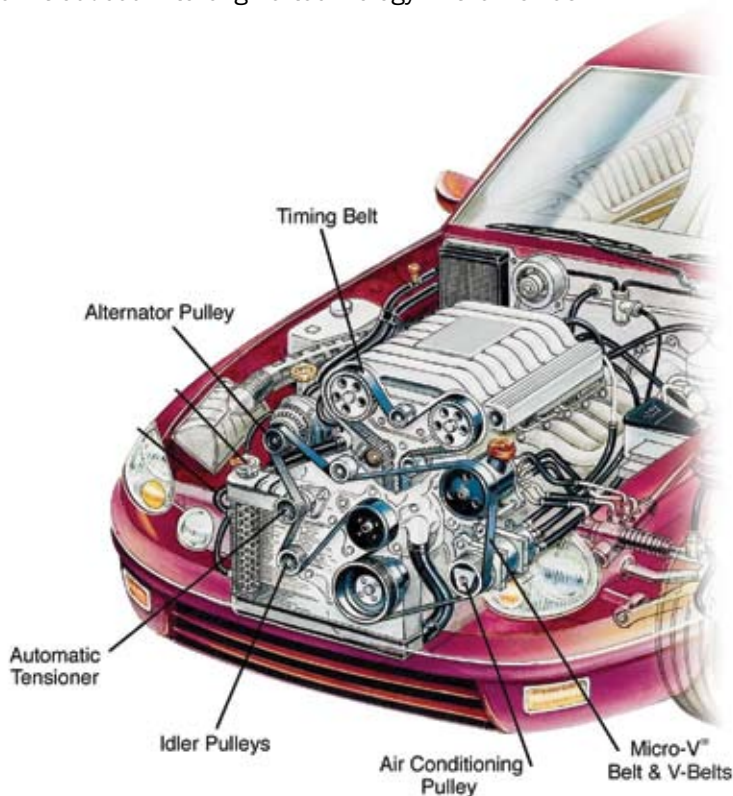

The first belt was made of polyurethane with steel cord tension members. During ongoing developments, polyurethane was replaced by very strong and temperature-resistant rubber materials. In addition, the tension member was changed to fiber glass, which provided excellent flex and very low elongation behavior.

During further engine developments, supported by the trend to overhead camshafts, synchronous (toothed) belt drive systems became more common in engines. This trend was also supported by the many advantages of toothed belt drives, including:

- More simple drives
- Flexible belt routing
- Lower cost
- Low elongation behavior and friction losses
- Constant timing over engine life
- Lower fuel consumption
- Less emissions



A timing belt is a flat, toothed rubber belt that synchronizes an engine's valve and piston movement.



If the belt tensioner pulley and idler pulleys are not changed together with the belt, early breakdown may occur, resulting in serious damage to the engine.

Timing System Operation

In an engine, the crankshaft drives the camshaft(s) and actuates the valves via a belt or a chain. The timing belt is widely used by car manufacturers because of its advantages over chain, namely reduced space, as well as lighter and quieter running.

Today, one out of every five passenger cars and light trucks use a timing belt to transmit power from the crankshaft to the camshaft(s). Most 4-cylinder and V-6 engines, as well as a few V-8s, use a timing belt. The timing belt is critical to the engine because it sets the engine's intake and exhaust valves in motion.

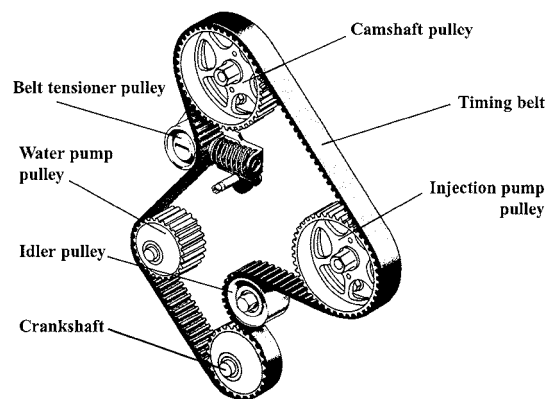

Note: Most belt drives on current production engines have recommended change intervals of 160,000kms or more.

Belt or Chain?

The benefits of using a belt include:

- Efficiency
 - A belt drive system can reduce up to 4.5 horsepower in friction loss.
- Less Vibration
 - A chain drive system shows lower transmission error. A belt drive system can be optimized to be equal or better than chain.
- Reduced Noise
- Creep/Wear
 - Current belt technology provides less than 0.1 percent total length change.
- Durability/Capability
 - Similar applications with belt drive systems are proven in the industry.
- Package
 - A belt drive system fits within the chain drive package.
- Weight
 - A belt drive system can save approximately 1.5 kg/3.3 lbs. per engine.
- Cost
 - Overall costs of implementing a belt drive system are generally lower than chain.
- Complexity
 - A belt drive system uses less components and part numbers.

Engines

Design

Overhead cam (OHC) engines come in two types: single overhead cam (SOHC) or dual overhead cam (DOHC). These cams are driven by the crankshaft by the use of a timing chain or a timing belt. There are lobes on the camshaft(s) that cause the exhaust and intake valves to open or close. These lobes contact the valves directly or by the use of cam followers. Despite their many differences, one thing all overhead cam engines share in common is a need for good upper valvetrain lubrication.

OHC timing belts can snap unexpectedly at high mileage. Heat and friction weaken the cords that reinforce the belt. The risk of failure goes up sharply after about 60,000 klm on most OHC engines built before the mid-1990s. This is why Gates, along with most vehicle manufacturers, recommends replacing OHC timing belts for preventative maintenance at 60,000-klm intervals.

Starting in the mid-1990s, OHC timing belts made of more durable materials began to appear with 90,000- to 100,000-klm replacement intervals. These new “long-life” belts, which are made of a special high-temperature grade of rubber called highly-saturated nitrile (HSN), were first introduced by Gates. HSN extends belt life up to 50 percent or more, and reduces the need for periodic belt replacement.

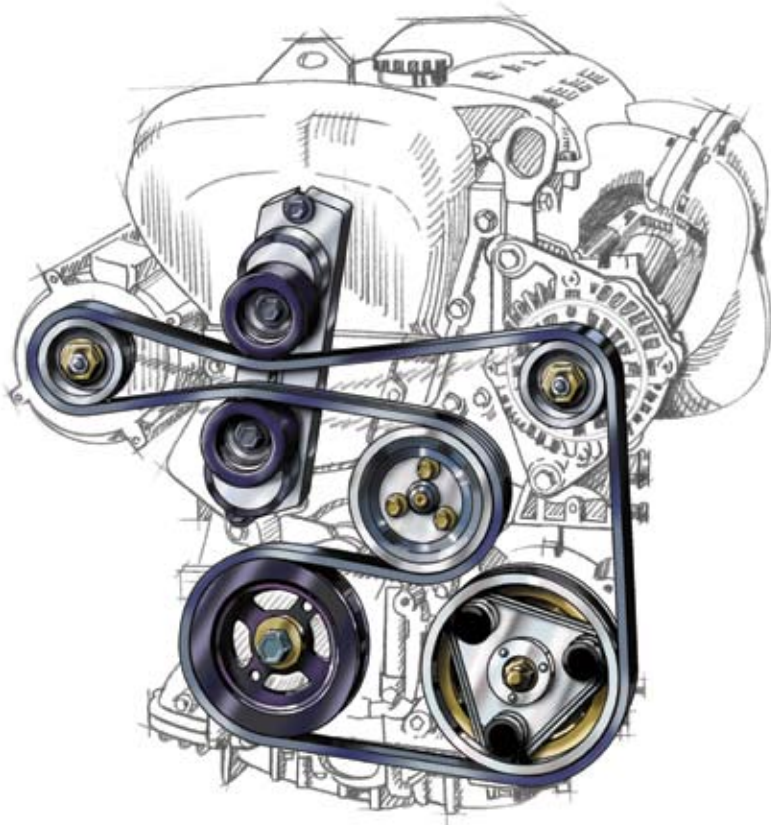

Gates was the first to introduce timing belts made of highly-saturated nitrile (HSN), a special high-temperature grade of rubber.

Free-Running or Interference

Automobile engines can be classified as either free-running or interference, depending on what occurs if piston/valve synchronization is lost.

As illustrated to the right, in the free-running engine with the crankshaft still moving, there is enough clearance between the valve and piston, even if the cam stops with a valve fully open.

However, with interference engines there is not enough clearance between the valves and pistons to prevent contact if the belt fails. Interference engines usually sustain damage if synchronization is lost.

As illustrated, disrupted synchronization allows the piston and valve to collide, causing damage and very expensive repairs for the vehicle owner. Damage can occur to valves, pistons or heads, and in some cases, completely ruin the engine.

Most import (with higher compression engines) and car and light truck diesel engines are interference. To avoid costly engine repairs, follow the auto manufacturers' mileage replacement recommendations.



Gates Timing Belt and Timing Tensioner Kit Wall Chart (part no. 496-204) makes finding interference easy.

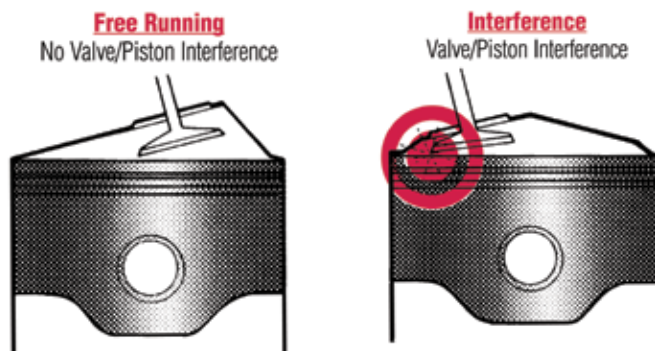

Balance Shaft versus Camshaft: 4-Cylinder Engines

Four-cylinder engines are attractive to vehicle designers because of their short, compact configuration. This allows them to be fitted transversely into the engine compartment, which frees up more space for passengers and cargo. In addition, short crankshafts and compact cylinder blocks save performance-robbing weight.

However, when 4-cylinder engines grow larger than about two liters in displacement, the second-order vibration (twice per engine revolution) set up by their pistons and connecting rods can become obnoxious.

The balance system consists of two parallel shafts on either side of the crankshaft. Driven by a toothed belt, the balance shafts rotate in opposite directions at twice engine speed. Eccentric weights built into the shafts generate inertial forces that counteract the second-order forces.

System Components

Timing System Component Identification

Engine timing systems utilize one or more of following components: idler or pulley, tensioner, hydraulic damper pivot arm and water pump.

Tensioners and idlers are important components that work hand-in-hand with the timing belt. If there is damage to a timing belt, Gates recommends that these parts be changed as well. Belt damage can occur from:

- Too much or too little tension
- Vibration
- High temperature
- Belt misalignment

When replacing any timing component, including tensioners, always refer to the vehicle's service manual.

After installation, always take a few extra minutes to look over all the components and check for proper operation. Make sure the pulleys rotate freely, check the belt tension and make sure bolts are tightened to the recommended torque values.

Idlers and Pulleys

The timing belt system uses idlers and/or pulleys to either change the direction of the belt or transmit power to a component such as a water pump or oil pump. Pulleys and idlers are either:



Smooth—located on the back side of the belt and typically used to change the direction of the belt to provide more wrap, or teeth in mesh, on a sprocket. They are also used to break up long spans to prevent belt flutter.



Notched—also called sprockets, are located on the tooth side of the belt and exactly match the tooth profile of the belt.

Note: Do not mix or match sprockets from similar makes and models during replacement. Only replace sprockets from a quality supplier for the specific application.

Pulleys are constructed of metallic or plastic material and a sealed bearing. The pulley bearings are a “wear” item and must be changed at regular intervals. Bearings are lubricated with premium grease and sealed at the factory to extend bearing life. On used bearings, be sure to look for seepage from the pulley bearing and examine the condition of the seal. If you're ever in doubt, replace the pulley. Also, check the condition of the bearing by checking for “roughness” when turning. Never clean bearings or add lubricants as this will shorten bearing life.



Squeezing or crimping a belt to a small radius can damage the internal cords. Timing belts do not stretch, so never attempt to force one around a pulley.



Gates offers an easy-to-use Timing Belt Tension Tester (Part No. 91000). This tester utilizes a compact design, measures timing belts up to 30mm wide and costs much less than more complicated tensioner testers.



System Components

Tensioners

Timing belt drives use three types of tensioning devices that must be installed per the vehicle manufacturer's instructions: manual tensioner, spring loaded tensioner and hydraulic damper pivot arm.



Manual Tensioner

Manual tensioners use a tension spring to apply the initial tension. Hook one end of the spring to the tensioner and the other end to the engine and tighten the tensioner bolts to the proper torque (see Service Manual for torque specifications).

Automatic Spring-Loaded Tensioner

Also known as a "frictional" tensioner, manufacturers are increasing their usage each year of the automatic spring-loaded tensioner because it provides a more consistent belt tension that can react and adjust to today's high-revving engines. Gates carries an extensive line of these tensioners, many of which were only available through the OEM until now.



Proper installation of these tensioners is critical and installation instructions must be followed. Once installed, belt installation is generally very simple. In most cases a hexhead wrench is used to rotate the tensioner into a position that permits the belt to slip into place. Once the belt is in place the tensioner is allowed to return to its operating position, applying the necessary tension.

Hydraulic Damper Pivot Arm

Several engine manufacturers use a pivot arm in correlation with a hydraulic damper to tension the belt. This damper uses a piston that pushes a pivot arm with a pulley, providing the required tension. When re-using the hydraulic damper, the piston will need to be driven back into its cylinder and locked in place. A vice can be used to retract the piston. Simply remove the damper from the engine, place it between vice jaws and slowly compress the piston. Once compressed, line up the holes in the piston with the holes in the cylinder and insert a pin to hold the piston in place. The Gates Pin Set is the only tool created just for this purpose (Part No. 91010).





NOTE: Proper tensioning of timing belts is very critical. Please refer to page 18 of this guide for more information.

Belts

Tooth Profiles

The earliest timing belts had a trapezoidal tooth profile. Competition and more demanding applications led to the development of a curvilinear profile. This in turn, evolved into a modified curvilinear profile. Belts with different tooth profiles are not interchangeable. Gates has the most complete timing belt line available, with more than 450 part numbers. The line includes both neoprene and HSN (highly-saturated nitrile) constructions, and all three tooth profile types:

- Trapezoidal 
- Curvilinear 
- Modified Curvilinear 

Neoprene was standard until 1985, when Gates introduced the first belts made of HSN. In short supply, and difficult to engineer, HSN was the material of choice for most new timing belts. An HSN-constructed belt appears no different than a neoprene belt, but significantly outperforms in the high-temperature engine compartments of modern vehicles.

In 2000, OEMs began using upgraded materials in timing belts, and Gates followed on aftermarket belts. While the name remained the same, this newer HSN is higher-grade on all drives requiring an upgrade. Rubber was not the only improvement made to timing belts; the cord and jacket material were upgraded as well.

Construction/Materials

Today's timing belts are highly sophisticated. The days of generic timing belts made of standard materials and tooth profiles are gone. Improved new generation belts are providing the extended durability and smoother performance characteristics required by today's engines. Gates leads the world in timing belt technology, assuring customers a replacement belt to match the capabilities of the original belts.



There are several different tooth shapes used by Gates and other timing belt suppliers. Some look very similar to one another but are different enough to drastically reduce the life of the timing belt if the wrong tooth shape is used.



While it is important to inspect belts whenever a vehicle comes in for service, it's not always possible to tell if a belt is still good by visual inspection alone.

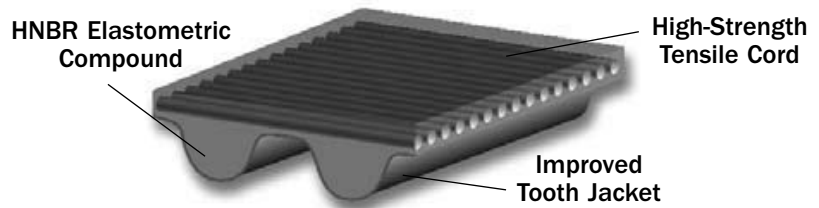

HNBR (or HSN) Elastomeric Compound

- Forms the main body of the belt
- Formulated for better heat resistance and durability
- Wide temperature range (-40° C to 140° C)
- Crack resistant

High-Strength Tensile Cord

- Designed for high-tension applications
- Normally S- and Z-twisted to prevent "tracking"
- High flexibility
- Heat resistant
- Fatigue resistant
- Low creep or zero-stretch

Improved Tooth Jacket

- Engineered for improved wear resistance
- Abrasion resistant
- Heat resistant
- Fatigue resistant

Expected Belt Life

Today's belts operate under heavier loads and are exposed to many factors that may cause premature failure, including: heat and temperature fluctuations, water, dirt, grease, oil and other environmental contaminants.

In addition, hotter, smaller engine compartments put more stress on belts and components. Idling time in traffic also takes a major toll on belt life. The engine runs hotter, and belts can break down much more rapidly in a car exposed to sustained periods of stop and go driving.

Sometimes, the first indication of a faulty belt is a squeaking noise coming from the engine compartment. While a warning of a possible malfunction, this noise is not a precise indicator. Therefore, it is imperative to inspect belts whenever a vehicle comes in for service. If there is ever any doubt, recommend replacement of the belts. The alternative could be a customer stranded in the middle of rush hour with a broken belt and a disabled vehicle.

OEM Recommended Replacement Intervals

Whether your customer's vehicle utilizes a free-running or interference engine, timing belt failures can be avoided by adhering to the OEM recommended replacement intervals and preventative maintenance. Most OEM-quality belts can be expected to last at least 100,000 klms, as long as there are no problems found with the other components that may cause premature system failure. Also, severe conditions such as towing, aggressive driving and maintenance history need to be considered.

Be aware that some manufacturers do recommend inspecting the timing belt without specifying a replacement interval. Gates does not advise this, as many timing belts that have failed or are about to fail may look as new as the day they were installed. Even if the belt doesn't look cracked, worn or oil-contaminated, it should be replaced at a reasonable mileage interval.

Gates PowerGrip Timing Belt Manual contains a timing belt replacement interval chart by application.

NOTE: A timing belt should be replaced, regardless of mileage, if it has become contaminated with engine oil or if it shows signs of premature cracking, shredding or general wear.

Customer Timing Belt Q&A

Since timing belts are inside the engine, they tend to be an out-of-sight, out-of-mind item and are seldom thought of as a part of routine maintenance. Here are some questions to ask customers that will help sell belts and protect the customer from expensive repairs:

1. Did you buy the car new?

If yes, they'll know if the belt has ever been replaced.

2. Did you buy the car used?

If so, they won't know if the belt has been replaced. This is a flag for the customer to get the belt checked, replaced or at least be aware that they have a timing belt.

3. How many miles are on the vehicle?

Generally belts should be replaced at around 100,000 klms or less. Gates Timing Belt Replacement Mileage Wall Chart (Product No. 428-0408) is an excellent tool for determining replacement intervals.

4. Have you ever replaced the timing belt?

If the answer is "yes" or "no" (and the customer knows the mileage), you can determine where the vehicle is in the replacement cycle.



A timing belt system inspection should be performed with any other under hood service on an engine with 50,000 klms or more.



Comparing OEM and Aftermarket Belts

Timing belt applications have increased dramatically. There are now more than 700 models of Australian and foreign-made cars and light-duty trucks with overhead cam engines using timing belts. This dramatic number of timing belt applications is the result of auto makers satisfying motorist's demands for spirited, responsive vehicles powered by efficient, multi-valve engines.

Gates timing belts are designed to handle the wide speed range and constant, synchronous drive power requirements common with these engines. When an engine is prepared for introduction into the market place, the timing belt is "engineered" for that particular engine.

Each timing belt part number offered by Gates represents a timing belt designed to work for a specific engine. One belt cannot fit multiple engines. A different Gates part number indicates the belt is "unique" and is different than all the other part numbers.

The aftermarket timing belt must be as good as or better than the OEM timing belt. When a new part number is released by Gates, we match the OEM belt for fit, form and function. The Gates aftermarket timing belt is thoroughly researched so that it matches the OEM for:

- Tooth profile
- Physical dimensions (length, width, etc.)
- Materials
- Timing marks
- Manufacturing requirements

All these attributes are very important, and since Gates is the leader in the supply of timing belts to the OEM, we are able to offer the same belt in the aftermarket.

Physical Dimensions

The dimensions of the timing belt are very important and must be closely maintained in order to function on the engine. A belt that is too long or short will not allow the tensioning device to operate in the intended range for which it was designed. This will result in excessive noise or even premature failure. Gates timing belts are manufactured with strict adherence to tolerances for all physical attributes.

Materials

The three main rubber compound designations that Gates uses to identify timing belts are:

- 1) Neoprene for older, easy running engines;
- 2) High Temperature Neoprene, which was an improvement over neoprene belts for heat resistance; and
- 3) HSN, which includes several different material combinations over the first two material options.

Not all HSN belts are alike. In addition to different rubber compounds, timing belt materials are made with different tensile members and belt jacket materials. The Gates aftermarket belt will match the look and feel of the OEM timing belt—exactly.



Timing Marks

Engine manufacturers will sometimes apply timing marks on the timing belt to assist in the installation of the belt. These marks are to ensure that the camshaft(s) is/are in “time” with the crankshafts. If the timing marks do not line up properly this is a warning to the installer that something isn’t set up right. Gates makes sure that these marks are located properly on the belt to remove the guesswork when installing timing belts.



Timing marks can be found on all relevant Gates aftermarket timing belts that require specific markings.



The most likely scenario for a prematurely-stripped timing belt is one in which the engine has been run low on oil

Failure Modes

Replacement

Always follow the vehicle manufacturer's instructions regarding belt replacement intervals. If the belt is removed, then a new belt should be installed. If the engine is being repaired and the belt is near OEM recommended replacement interval, it's a good time to replace it.

Replacing all wear items in the system each time a belt is replaced is also a good idea. Since a large part of the repair bill is the labor involved in changing a timing belt, it makes sense to replace all the components at the same time. For the majority of engines, Gates offers all the components in the timing belt drive such as:

- Timing belt
- Idler(s)
- Tensioner
- Water pump
- Seals
- Installation instructions



Checking the Belt

Determining the true condition of a timing belt is not easy for two reasons:

1. Most timing belts are hidden beneath covers that must first be removed to inspect the belt.
2. A simple visual inspection won't necessarily tell you if a belt is good or bad. Some belts that look like new on the outside are dangerously weak on the inside and may fail without warning.

Belt Tensioning

Proper tensioning of timing belts is very critical. High belt tensions can result in:

- excessive noise such as a “whining” sound
- early bearing failure due to the increased loading of the bearing by the belt
- damage to the land area of the belt, leading to tooth cracks and/or tensile member failure

Low belt tensions can:

- lead to the belt flapping and possibly hitting the covers
- put higher stress on the belt teeth resulting in early failure by “shearing” teeth off the belt

It is recommended that the belt tension be checked by a proper tool, such as Gates Timing Belt Tension Tester, (Part No. 91000) once tensioners are installed. Tension springs are not included in Gates Timing Component Kits.

Warranty Returns

At Gates we do everything possible to prevent timing belt returns. We provide the right belt for the application and offer instructions, tools and system components to help ensure the job is done right.

Timing belts are returned because the engine failed prior to the next scheduled maintenance interval. In most cases the timing belt takes the blame for other engine component failure.

If a belt is returned, some simple checks can determine the cause of failure. Typical returns can be traced back as being caused by:

1. Using the incorrect belt for the application
2. Improper installation
3. Other component failure
4. Technical Service Bulletins (TSBs) not followed or known about
5. Timing components used beyond their recommended life



The timing belt drive must be looked at as a “system”, and it is crucial that every component in the system be properly maintained.



Installing a timing belt at higher-than-recommended tensioners drastically reduces the life of the bearings.

Determining if the correct belt for the application was used may sound simple, but sometimes little things can be overlooked. For example:

- There are some aftermarket timing belts that are the same length but are intended to be used on completely different applications.
- An older engine may have only required a Neoprene belt, while the newer engine required an HSN belt and the installer tried to save some money and installed the wrong belt.
- An older engine was replaced with a newer one and the customer was given a belt based on the year of the car and not the year of the engine.

After checking that the belt is correct for the engine, a look at the belt can help point to the root cause. Refer to the Troubleshooting Guide on page 23 of this training guide or Gates PowerGrip Timing Belt Replacement Manual for examples of failed belts and possible causes and solutions.

To properly determine what caused failure, all the system components must be reviewed. If only the belt was replaced initially, then another component is probably at fault. All moving components in the drive are subject to wear and need to be replaced at recommended intervals or sooner.

For instance, it is highly recommended on systems that include a water pump in the drive that the water pump be replaced at the same time as the timing belt. Bearings in water pumps, idlers and tensioner pulleys are subject to extreme operating conditions and need to be replaced. If a belt was installed at higher-than-recommended tensions, this will drastically reduce the life of the bearings.

A quick review of the installation instructions can sometimes point out pit falls an installer may have encountered. The mechanic needs to follow all the instructions and follow up with an operational check to make sure the system is functioning properly. This is the last opportunity for the mechanic to make corrections before the next belt change. After installation is complete, be sure to run the engine and check for noise, vibrations and engine performance.

Manufacturing Defects

Gates manufacturing facilities have implemented several quality control processes and procedures to virtually eliminate defects in manufacturing. The only thing the customer needs to make sure of is that the Gates belt is the same as the belt they are replacing. Things to look for include:

1. Belt dimensions (length and width).
2. Tooth shape correct for sprockets.
3. Timing marks.
4. Directional arrows (these are used to make sure the belt is running in the proper direction of rotation for the belt timing marks to line up with the engine marks).

Proper Handling of Timing Belts



Synchronous belts have been used on automotive camshaft drives for more than 20 years. Gates belts will give OEM equivalent service if the following points are observed.

- Do not allow timing belts to be crimped! If the tensile members in a timing belt are bent, then the strength is drastically reduced and the belt will fail prematurely.
- Do not use any solvents to clean a timing belt.
- Always replace belts that have been contaminated with engine fluids such as oil, grease and anti-freeze. These substances can break down the rubber compounds and destroy the glue that holds the different parts of the belt together.
- Do not rub the sides of the belt, twist the belt excessively or use tools to pry the belt onto the drive. Tools will damage the belt and create weak points that can lead to premature failure.
- Always store belts in the original box and do not stack heavy objects on the belts as this will twist or kink the belt. Store belts in an environment that avoids:
 - Temperature extremes
 - Direct sunlight
 - High humidity
 - Contamination by oil, water, chemicals, etc.
- Replace and properly refit the timing cover to prevent drive contamination by foreign matter.

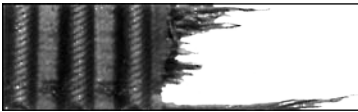
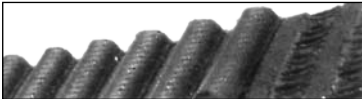

Always store belts in the original box to avoid damage and premature failure.

Timing Belt Troubleshooting

Symptom	Probable Cause	Concern/ Corrective Action
	<ol style="list-style-type: none"> 1. Excessive shock load. 2. Improper belt handling and storage prior to installation. 3. Debris or foreign object in drive. 4. Extreme pulley/sprocket run-out. 5. Extreme over-tension. 	<ol style="list-style-type: none"> 1. Excessive RPMs; modified engine. 2. Follow proper storage and handling procedures. 3. Remove objects; replace pulleys. 4. Replace pulley/sprocket. 5. Adjust tension to recommended value.
	<ol style="list-style-type: none"> 1. Seized drive component(s). 2. Excessive shock loads. 3. Extreme sprocket run-out. 4. Worn sprocket. 5. Misaligned drive. 6. Belt under-tensioned. 	<ol style="list-style-type: none"> 1. Replace component(s): tensioner, idler/pulley, water pump, camshaft, oil pump. 2. Excessive RPMs; modified engine. 3. Check camshaft/crankshaft journals. 4. Replace sprocket. 5. Worn sprocket bearing: replace sprocket; bent bracket: improper sprocket installation. 6. Adjust tension to recommended value.
	<ol style="list-style-type: none"> 1. Too low or high belt tension. 2. Belt running partly off unflanged sprocket. 3. Misaligned drive. 4. Worn sprocket. 	<ol style="list-style-type: none"> 1. Adjust tension to recommended value. 2. Correct alignment. 3. Worn sprocket bearing: replace sprocket; bent bracket: improper sprocket installation. 4. Replace sprocket.

Failure Modes

Symptom	Probable Cause	Concern/ Corrective Action
Backside Cracks	<ol style="list-style-type: none"> 1. Extreme high temperature. 2. Extreme low temperature at start-up. 3. Cocked sprocket. 4. Excessive tension. 	<ol style="list-style-type: none"> 1. Overheated engine; seized or partially-seized pulley. 2. Install engine heater. 3. Replace sprocket. 4. Adjust tension to recommended value.
Land Wear (wear between teeth)	<ol style="list-style-type: none"> 1. Excessive tension. 2. Worn sprocket. 	<ol style="list-style-type: none"> 1. Adjust tension to recommended value. 2. Replace sprocket.
Contamination	<ol style="list-style-type: none"> 1. Oil, fuel or coolant leak. 	<ol style="list-style-type: none"> 1. Replace faulty seals and/or gaskets; check timing cover for improper installation, replace if cracked or worn.
Edge Wear	<ol style="list-style-type: none"> 1. Damage due to handling. 2. Flange damage. 3. Belt tension too low. 4. Rough belt pulley flange. 5. Improper tracking. 6. Belt contacting engine, timing cover or other engine component. 	<ol style="list-style-type: none"> 1. Follow proper handling instructions. 2. Replace sprocket. 3. Adjust tension to recommended value. 4. Replace sprocket. 5. Correct alignment. 6. Remove obstruction or correct alignment.
Unusual Noise (not shown)	<ol style="list-style-type: none"> 1. High tension. 2. Low tension. 3. Misalignment. 4. Damaged pulley flange. 	<ol style="list-style-type: none"> 1. Adjust tension to recommended value. 2. Adjust tension to recommended value. 3. Worn sprocket bearing: replace sprocket; bent bracket: improper sprocket installation. 4. Replace pulley(s).

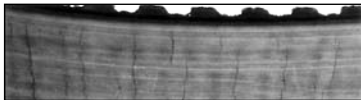

Failure Modes

PowerGrip™ Timing Tensioner Kit

Gates PowerGrip™ Timing Tensioner Kit gives you the best and most complete repair solution for your customers. Save time and money by preventing costly comebacks and warranties. The Kit is ideal for the consumer because the job is done right the first time; saving them from returning when other components fail and accruing additional labor costs.

With Gates PowerGrip kits, it's not necessary to multi-source components, look up several different manufacturers or present your customer with several cartons containing different parts. One carton includes all the components required to do a thorough job. Kits can contain multiple belts, tensioners, idler and tensioner pulleys, depending on the application.

